

Contents

Installation, 2

Installation
Specifications

Description of the appliance, 3

Microwave oven function

Beginning and use, 5

Setting the clock
Safety Block
Operating mode
Special Function: DRINK
Special Function: POPCORN
Special Function: FRESH VEGETABLES
Microwave Function
Defrost by weight (Automatic)
Defrost by tome (Manual)
Important notes
During operation
Interrupting the operation
Working with microwaves

Precautions and Advices, 9

General security
Eliminating
Practical advices

Microwave Oven Maintenance, 11

Remove the plug from de socket
Cleaning
Light replacement
Solving problems
Cord replacement

MWH 121

Installation

! It is important conserve this book to consult at any moment. Keep the operating instructions in a safe place ready to pass on in the event of change of ownership.

! Read the instructions in this book carefully: the instructions contain important information regarding appliance and care.

Installation

Remove the microwave oven from packing.

Remove all packing materials and accessories from the microwave oven cavity.

• Check whether the following parts are in good condition:

- Door and hinges;
- Front of the microwave oven;
- Inside and outside of microwave oven.

! Do not use the appliance if you find any faults do not use the microwave oven, and contact your dealer.

• Place the appliance on a stable, flat surface.

- To allow efficient cooling of the microwave oven its installation is recommended in a unit with an opening in the upper part (refer to the installation instructions leaflet enclosed).

! The microwave oven plug shall be accessible after installation.

- When installing the microwave oven great care should be taken to ensure that the mains power cable cannot come into contact with the rear since the high temperatures involved could cause damage.

- When the microwave oven is installed in a column with a conventional oven, the microwave oven must not be located underneath the conventional oven because of the possibility of condensation forming inside the latter.

The microwave oven has been supplied with a mono-phase power supply cord. The appliance must be earthed.

! This appliance must be earthed.

! The manufacturers and dealers are not liable for any breakdowns or personal accidents should these installation instructions not be observed by the purchaser.

Specifications

AC voltage	230 V / 50 Hz
Fuse	12 A / 250 V
Power required.....	1200 W
Microwave output power.....	800 W
Microwave frequency.....	2450 MHz
Outer dimensions (WxAxD).....	595 × 390 × 320 mm
Cavity dimensions (WxAxD).....	305 × 210 × 280 mm
Oven capacity	18 ltr
Weight	18,6 kg

Description of the appliance

 Hotpoint

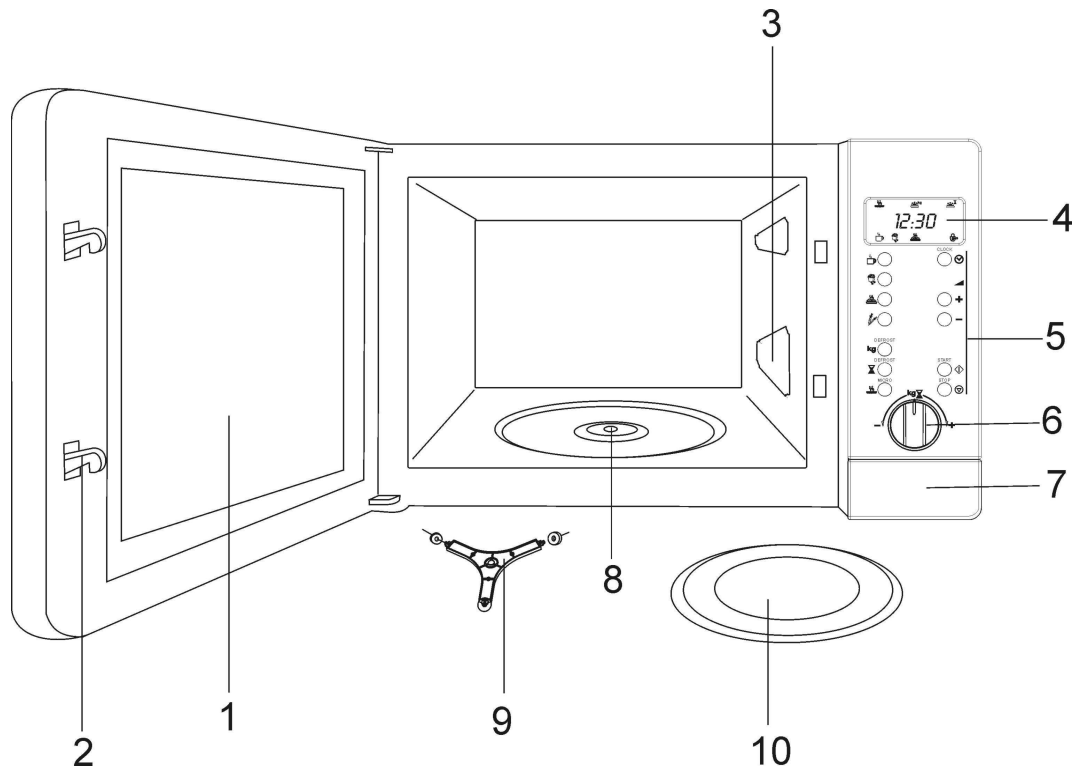

- 1 – Glass window on the door
- 2 - Catch
- 3 – Mica covers
- 4 – Screen
- 5 – Function Selector

- 6 – Timer Selector
- 7 – Open button
- 8 – Slot for rotating base
- 9 – Rotating base
- 10 – Rotating plate

Microwave oven function:

In a conventional oven the heat radiated by the resistances or gas burners, slowly penetrates the food from the outside to the inside. There is, therefore, a great loss of energy in the heating of the air, oven components and recipients.

On the other hand, in microwave ovens the heat is generated in the interior of the food itself, heating it from the inside outwards. There is therefore no loss of energy as the air, interior walls of the oven and recipients (when adequate) do not heat up with microwaves.

Microwave ovens have the following advantages:

1. Save on cooking time: in general there is a 3/4 reduction of the cooking time than with conventional methods.
2. Ultra-quick defrosting that prevents bacteria development.
3. Electricity saving.
4. Maintaining the nutritive value of the food due to the cooking time reduction.
5. Easy cleaning.

In the microwave oven there is a high voltage valve called "Magnetron" that converts electric energy to Microwave energy. These electromagnetic waves are conducted to the inside of the oven cavity by means of wave-guide and spread by a mode stirrer or by a turntable.

Inside the oven, the Microwaves spread out in all directions and are reflected by the metallic walls, penetrating the food evenly.

Most food contains water, whose molecules vibrate with Microwaves.

The friction between the molecules generates heat, which causes a temperature rise in the food, defrosting it, cooking it or keeping it warm.

As the heat is formed inside the food:

- It may be cooked with little or no liquid or fat;
- Defrosting, heating or cooking in the microwave oven is quicker than in a conventional oven;
- Vitamins, minerals and nutritive substances are preserved;

The Microwaves pass through porcelain, glass, cardboard and plastic but not through metal. Therefore, recipients made of or containing metal should not be used in the microwave oven.

The Microwaves are reflected by the metal...

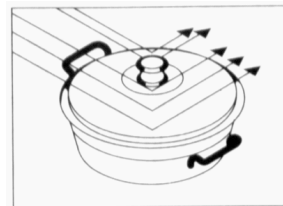

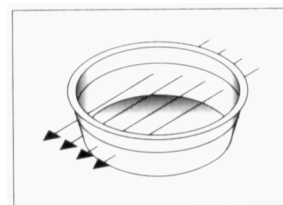

...they pass through Glass and Porcelain...



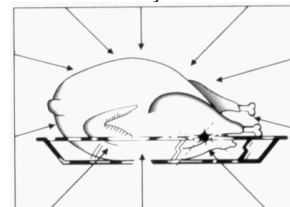

...and they are absorbed by the food.



Setting the clock

1. Press the CLOCK  key until the digits start blinking.
2. Enter the hour by turning the ROTATING KNOB in both directions.
3. Press the CLOCK key  again to change the minutes.
4. Enter the minutes by turning the ROTATING KNOB in both directions.
5. Press the CLOCK key  to stop.



Safety Block

1. The microwave oven operation can be blocked (for example: to prevent it from being used by children) by pressing the STOP  key for 3 seconds. The microwave beep and the appliance will be blocked. It continues to display the time and the Safety Block  function indicator will light up.
2. To unblock it, press the STOP  key for 3 seconds. At the end of this time there is an alarm sound and the Display show the clock once again.



Operating mode

1. Connect the oven to a suitable power source (see the Installation Instructions).
2. Open the door by pressing the "Open" button.
3. Place the container with the food on the tray or grille.
4. Select the desired function and cooking time in accordance with, the description provided following chapters.
5. Close the door and press the START  key.
6. The microwave oven starts working. The Display shows the functioning time decreasing.



Special Function: DRINK

1. Place the drink (approx. 150 to 300 ml of coffee, tea, milk, water, etc.) in a heat resistant recipient on the turntable.
2. Press the Special Function DRINK  key: the Special Function Drink indicator light up.
3. Press the START  key. The oven starts working.



Special Function: POPCORN

1. Place the corn (100-150 g) in a heat resistant recipient with a lid. Add a little butter or cooking oil and sprinkle with salt or sugar as desired.
2. Press the Special Function POPCORN  key: the Special Function Popcorn indicator light up.
3. Press the START  key. The oven starts working.





Special Function: RICE

1. Place a cup of rice (approx. 200 g) and 1-½ cups of water into a glass bowl with lid. Add salt, oil etc. as desired and mix everything.
2. Place the glass bowl with the lid on the oven turntable.
3. Press the Special Function RICE  key: the Special Function Rice indicator light up.
4. Press the START  key. The oven starts working.
5. At the end, there is a standing time during which the oven continues working and the Special Function RICE indicator blink.



Special Function: FRESH VEGETABLES

1. Place 300-400 g of fresh vegetables (broccoli, cabbage, carrot, etc.) and 45-60 ml of water in a heat resistant recipient with a lid. Add salt as desired.
2. Press the Special Function FRESH VEGETABLES  key: the Special Function Fresh Vegetables indicator light up.
3. Press the START  key. The oven starts working.
4. At the end, there is a standing time during which the oven continues working and the Special Function fresh vegetables indicator blink.



Microwave Function

1. Press the MICROWAVE  key: the Microwave Function indicator light up.
2. Enter the operating time (for example: 10 minutes), by turning the ROTATING KNOB in both directions.
3. To change the Microwave power, press the  and  keys. If these keys are not pressed, the microwave oven work as default at maximum power.
4. Press the START  key. The oven starts working.

Defrost by Weight (Automatic)

1. Press the DEFROST BY WEIGHT **kg** key: the Defrost by Weight Function indicator light up.
2. Enter the type of food, by pressing the **—** and **+** keys. If these keys are not pressed, it select type 1 food as default.
3. Enter the food weight (for example: 1,2 kg), by turning the ROTATING KNOB in both directions.
4. Press the START  Key. The oven starts working.
5. When the oven stops and the alarm sounds, open the door and turn the food over. Close the door and press the START  key.

Defrost by Time (Manual)

1. Press the DEFROST BY TIME  key: the Defrost by Time Function indicator light up.
2. Enter the defrosting time (for example: 12 minutes), by turning the ROTATING KNOB in both directions.
3. Press the START  key. The oven starts working.
4. When the oven stops and the alarm sounds, open the door and turn the food over. Close the door and press the START  key.

IMPORTANT NOTES:

- In the Defrost by Weight function, the introduced weight is that of the food alone, not including the dish.
- Use the Defrost by Weight function only for raw food.
- This function has better results if the food is at a temperature of -18°C and if the food is taken directly from the freezer to the oven.
- If the food is at a higher temperature (either because it isn't a 3 star freezer or because the food has been out of the freezer for more than 20 minutes) the oven calculated time will be more and there may be a risk of fire. In these cases, select a weight, which is lower than the real food weight.
- In the cases above and when the food is already cooked and frozen, use the Defrost by Time function, starting with short periods of time.
- When you use tin foil to protect the thinner parts of the food, make sure that it doesn't touch the oven walls, otherwise there may be damages.
- Turn the foods around the moment the microwave beeps and starts to flash on the screen: **"Turn"**. Close the door and press the START  button, to continue the cooking process.

The following table describes the different Defrost by Weight programmes; the respective weight ranges; defrost time ranges; standing time ranges (to allow temperature evenness) and recommendations.

Code	Food	Weight	Defrost Time	Standing Time	Recommendation
1	Meat	0,1 – 1,5 kg	4 – 61 min	20 – 30 min	Cover the thinner ends with tin foil. Turn the meat when the oven whistles sounds.
2	Poultry	0,1 – 1,5 kg	4 – 61 min	20- -30 min	Cover the thinner ends with tin foil. Turn the meat when the oven whistles sounds.
3	Fish	0,1 – 1,5 kg	4 – 63 min	20 – 30 min	Cover the tail of the fish with tin foil. Turn the fish when the oven whistles sounds.
4	Fruit	0,1 – 0,5 kg	2 – 13 min	5 – 10 min	Place the fruit in a glass dish and cover it during defrosting and standing time.
5	Bread	0,1 – 0,8 kg	2 – 19 min	5 – 10 min	Place the bread on the glass turntable covered with kitchen paper towel.

During Operation...

The microwave oven door may be opened at any time during the cooking operation, in which case:-



- The production of microwaves is immediately interrupted;
- The Timer is automatically stopped, indicating the remaining cooking time.

Then, if you wish you may:

- Stir or turn the food, to improve uniform cooking;
- Change the Microwave power level by pressing the **—** or **+** keys;
- Select another function, by pressing the Function keys;
- Change the operating time left by turning the ROTATING KNOB.
- Close the door again and press the START  key. The oven restarts working.

Interrupting the Operation

To stop the microwave oven before completing its programmed time, press the STOP  key or open the door.

If you don't wish to continue cooking the food, close the door and press the STOP  key again. The oven emits a sound and the Display show the Clock. At the end of the functioning time, the microwave oven stop, emit 3 signal sounds and the Display show the word "End". The sound signals are repeated every 30 seconds until the door is opened or the STOP  key pressed.

Working with Microwaves

Before using any dish, make sure that it is appropriate for use in microwaves (SEE ADVICE ON THE USE OF UTENSILS AND RECIPIENTS).

Always make a slit in the food's shell before cooking it.

Whenever heating liquids use a recipient with a large opening to allow the vapour to escape.

Remember that...

1. Larger quantities of food require more cooking time.
2. The lower the food temperature the more cooking time is needed.
3. Less dense foods cook faster.
4. An even distribution of the food in the oven guarantees better results. The cooking of different types of foods simultaneously is possible by placing the dense food in an outside circle and the less dense in the centre of the plate.
5. Better results are achieved by allowing the food to stand before serving because it continues to cook for some time after the oven is switched off.
6. The cooking time may be shortened and the liquids preserved (the food doesn't dry out) by covering the food. The lids should be transparent to allow the microwaves through and they should have a small opening for the vapour to escape.

General security

! If the door or the door hinges are damaged, the oven should not be switched on until repaired by a qualified technician.

! It is dangerous for anyone, except a qualified technician, to tamper with the apparatus or try to repair it in any way by removing any lid or covering which assures protection against the exposure to microwave energy.

! Liquids and other food should not be heated in airtight recipients as these can explode.

! Children should only be allowed to use the oven without adult supervision if they have been given the appropriate instructions so that they can use the oven safely and understand the dangers of its incorrect use.

! When the microwave oven is operated in the Combination mode (Microwaves + Grill), children should only be allowed to use the unit under adult supervision due to the high temperatures generated.

! The microwave oven should be cleaned regularly and any food deposits removed (please see the chapter on Oven Maintenance for details). Failure to maintain the oven in a clean condition could lead to deterioration of the surface that could adversely affect the life of the appliance and possibly result in a hazardous situation.

- When heating food in plastic or paper recipients, check the oven frequently in case they ignite.
- If any smoke is detected, then switch off the oven or disconnect it and keep the door closed in order for any flame to die out.
- After warming up baby bottles or baby food jars stir or shake its contents and check the temperature before feeding, to avoid burns.
- Warming up drinks in the microwave oven may result in a delayed eruptive boiling; therefore one should be careful when handling the recipient.

- Eggs with their shell and whole boiled eggs shouldn't be warmed up in microwave ovens as they may explode, even after microwave heating has ended.
- Only use utensils that are suitable for use in microwave ovens. Do not use any metal utensils inside the oven unless they were supplied with the oven and for that purpose.
- Do not warm up liquids or other food in closed recipients as they may explode.
- Do not warm up pure alcohol or alcoholic drinks. FIRE DANGER.
- When in doubt, choose short periods to cook heat or defrost food with microwaves. With long cooking periods the food may become dry and even begin to burn.
- Do not use the microwave oven for anything other than warming, cooking or defrosting food.
- Do not operate the microwave oven without its tray nor when empty.
- Keep the microwave oven ventilation holes open. Never cover any air vents or openings.

Eliminating

- Eliminating the packing materials: use the right bins when discarding all of packing materials. This will ensure that the packaging materials are recycled.

The European Directive 2002/96/EC on Waste Electrical and Electronic Equipment (WEEE), requires that old household electrical appliances must not be disposed of in the normal unsorted municipal waste stream. Old appliances must be collected separately in order to optimize the recovery and recycling of the materials they contain and reduce the impact on human health and the environment.

The crossed out "wheeled bin" symbol on the product reminds you of your obligation, that when you dispose of the appliance it must be separately collected.

Consumers should contact their local authority or retailer for information concerning the correct disposal of their old appliance.

Practical advices

- Use heat resistant ovenware made of glass, glass, ceramic, and porcelain, ceramic or heat-resistant plastic. These materials do not block the microwaves.
- This is not the case with ovenware made of metal. The microwaves are obstructed which means that the food in closed containers remains cold. Ensure that any metal objects – e.g. a spoon – are at least 2 cm away from the oven walls and the inside of the door. The glass on the inside of the door could be damaged by sparks.
- To cook or defrost pieces of meat of irregular sizes, you may cover the thinner parts with tin foil, which should be kept at least 2 cm away from the oven walls, otherwise these may cause an electric arc.
- Metal spits may be used as long as they are smaller than the pieces of meat.
- Crystal contains a percentage of lead, which may cause it to crack if used in the microwave oven. The same may happen to glass dishes with jagged edges.

! Porcelain dishes may be used but they should not have hollow handles. Humidity may be formed inside the hollow handles, which will cause an increase in pressure that may cause them to break.

! This type of dish may heat considerably.

Painted glazed ceramic dishes may be used if the painting is done under the glaze.

Many glazes and colours contain metallic substances. If this is the case they should not be used in the microwave as they may be damaged.

Recipients with silver and gold glazes may go dark.

! Plastic dishes should be heat resistant (at least 180° C) or they may be deformed when used in the microwave. Melamine dishes are not suitable for use in the microwave as they heat up too much

To cook or heat food in plastic bags, they should be perforated to allow vapour to escape thus preventing the bag from bursting.

! Wooden recipients should not be used in the microwave. Wood contains water, which evaporates and may cause the recipient to crack.

Microwave Oven Maintenance



- If in doubt about the use of glass, glazed ceramic or porcelain dishes in the microwave oven, do the following test:

- Place the empty dish and a glass of water inside the microwave oven;

- Close the door;

- Set the Power Level Selector at maximum power;

- Adjust the timer to 1 minute;

! If during this test you hear any noise along with sparks, turn off the oven immediately.

- Any kind of cookware that has this kind of behaviour or is very hot when removed from the oven should not be used in the microwave oven.

! Glazed ceramic dish recipients contain many water molecules and heat a lot, but can be used in the microwave oven.

If in doubt, contact the supplier of the cookware, and make sure that they are appropriate for microwaves.

The use of glass lids, plastic lids or plastic film is advisable because:

1. They prevent the release of excessive vapours especially when cooking for longer periods.
2. They increase the speed of heating food.
3. They prevent the food from drying up.
4. They prevent the loss of the food aroma.

The lids should have holes to avoid pressure. Plastic film should be perforated.

Baby bottles, baby food jars and other similar recipients should be warmed up without lids as they can burst.

Remove the plug from the socket

Make sure that the oven is unplugged before cleaning the oven.

Don't use abrasive cleaning products.

Cleaning

Outside

1. Clean the outside surface with neutral detergent, lukewarm water and dry it with a damp cloth.
2. Avoid water from entering the oven ventilation holes.

Inside

1. Clean the oven walls with a damp cloth after each use.
2. Avoid water from entering the ventilation holes in the oven's interior.
3. If some time has passed by since the last cleaning and the oven's interior is dirty, place a glass of water on the tray and switch on the oven for 4 minutes on the highest setting. Moisture will form on the oven walls, which will be easily cleaned.
4. The tray can be washed with regular dish washing detergent or in the dishwasher.

Door, door seal, and oven front

1. These parts should always be clean, especially the contact surface between the door and the oven front, to prevent microwave leakage.
2. Use neutral detergent, lukewarm water and dry the surface with a soft cloth.

Light Replacement

The light bulb may only be replaced by the Technical Support Service.

Solving Problems

Repairs or interventions carried out by an unqualified serviceman can cause dangerous situations.

Every and any kind of repair or intervention should be done by the manufacturer, authorized agents or qualified technicians.

If you detect any abnormalities in the oven, check the following before you contact T.A.S:

1. Check if the outlet into which the oven is plugged has power. To do so, plug another appliance into the same outlet and check if it works.
- 2 If the oven lamp switches on, but the food does not heat up, check if the door is well closed (if the door is not properly closed, no microwaves will be produced).

Cord Replacement

If the cord is damaged, it should be replaced by the manufacturer, authorized agents or qualified technicians in order to avoid any dangerous situation and also because special tools are required.

